

Agile Elite C140 Rolling Mill

Dimensions is MM

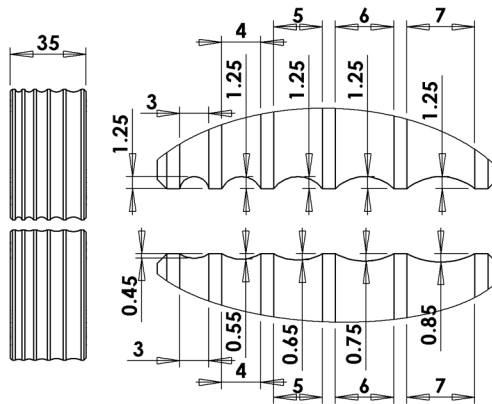

**Top
Extension
Comfort Fit**



**Bottom
Extension
Comfort Fit**

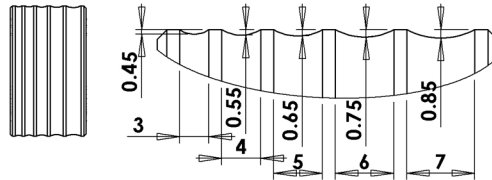

**Extension
Roll No1**

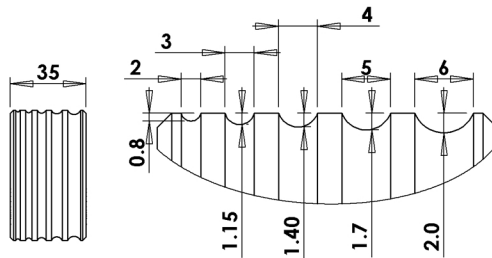

**Extension
Roll No2**

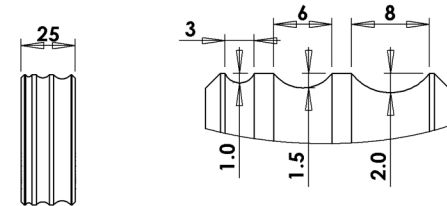

**Extension
Roll No3**

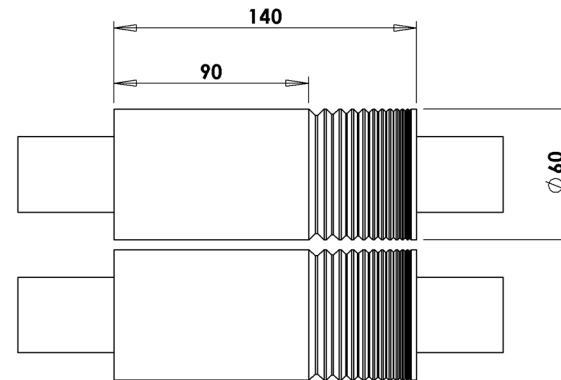
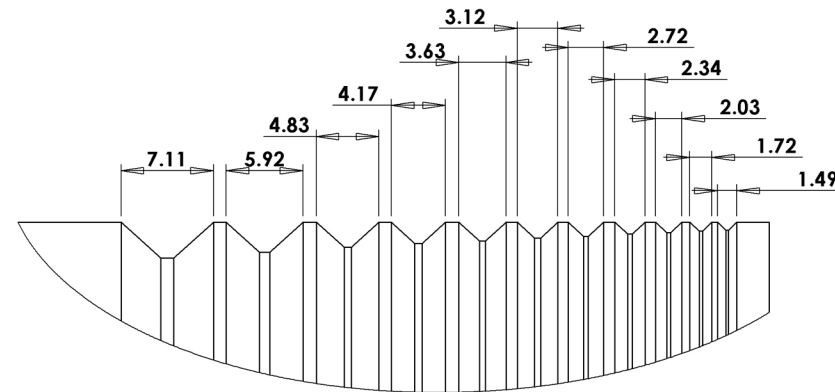
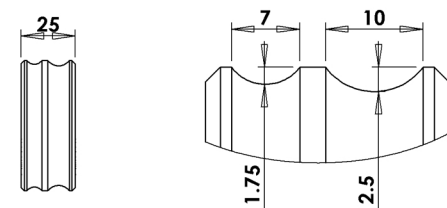

Agile Elite C140 Rolling Mill

Dimensions is MM



**Extension
Roll Plain**

